

Всеукраїнський науково-технічний журнал

Ukrainian Scientific & Technical Journal

ISSN 2306-8744

DOI: 10.37128/2306-8744-2022-1

Вібрації в техніці та технологіях



Всеукраїнський науково-технічний журнал

Ukrainian Scientific & Technical Journal

Вібрації в техніці та технологіях

№ 1 (104)

Вінниця 2022

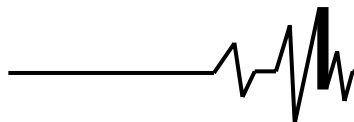
**ВІБРАЦІЇ В
ТЕХНІЦІ ТА
ТЕХНОЛОГІЯХ**

Журнал науково-виробничого та навчального
спрямування Видавець: Вінницький національний
аграрний університет

Заснований у 1994 році під назвою “Вібрації в техніці та
технологіях”

*Свідоцтво про державну реєстрацію засобів масової
інформації*

КВ № 16643-5115 ПР від 30.04.2010 р.

*Всеукраїнський науково-технічний журнал “Вібрації в техніці та
технологіях” / Редколегія: Калетнік Г.М. (головний редактор) та інші. – Вінниця,
2022. – 1 (104) – 137 с.*

*Друкується за рішенням Вченої ради Вінницького національного аграрного
університету (протокол № 10 від 29.04.2022 р.)*

*Періодичне видання включено до Переліку наукових фахових видань
України з технічних наук (Категорія «Б» Наказ Міністерства освіти і науки
України від 02.07.2020 р. № 886)*

Головний редактор

Калетнік Г.М. – д.е.н., професор,
академік НААН України, Вінницький
національний аграрний університет

**Заступник головного
редактора**

Адамчук В.В. – д.т.н., професор, академік
НААН України, Національний науковий
центр “Інститут механізації та електрифікації
сільського господарства”

Відповідальний секретар

Солона О.В. – к.т.н., доцент, Вінницький
національний аграрний університет

Члени редакційної колегії

Булгаков В.М. – д.т.н., професор, академік
НААН України, Національний університет
біоресурсів і природокористування України

Граняк В.Ф. – к.т.н., доцент, Вінницький
національний аграрний університет

Деревенько І. А. – к.т.н., доцент,
Національний університет «Львівська
політехніка»

Зіньковський А.П. – д.т.н., професор,
Інститут проблем міцності імені Г. С.
Писаренка НАН України

Купчук І.М. – к.т.н., доцент, Вінницький
національний аграрний університет

Матвєєв В.В. – д.ф.-м.н., професор,
академік НАН, Інститут проблем міцності
імені Г.С. Писаренка НАН України

Полєвода Ю.А. – к.т.н., доцент, Вінницький
національний аграрний університет

Севостьянов І.В. – д.т.н., професор,
Вінницький національний аграрний
університет

Твердохліб І.В. – к.т.н., доцент, Вінницький
національний аграрний університет

Токарчук О.А. – к.т.н., доцент, Вінницький
національний аграрний університет

Цуркан О.В. – д.т.н. доцент, Вінницький
національний аграрний університет

Зарубіжні члени редакційної колегії

Максімов Джордан Тодоров – д.т.н., проф., Технічний Університет Габрово (Болгарія)

Технічний редактор **Замрій М.А.**

Адреса редакції: 21008, Вінниця, вул. Сонячна 3, Вінницький національний аграрний
університет, тел. 46 – 00– 03

Сайт журналу: <http://vibrojournal.vsau.org/>

Електронна адреса: vibration.vin@ukr.net

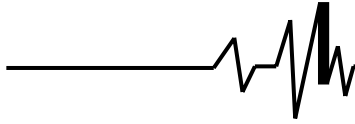
**З М І С Т****1. ТЕОРІЯ ПРОЦЕСІВ ТА МАШИН**

<i>Sevostianov I., Ivanchuk Ya.</i> ELABORATION AND RESEARCHES OF A VIBRO-PRESS FOR DEHYDRATION OF DAMP DISPERSIVE MATERIALS.....	5
<i>Цуркан О. В.</i> ПЕРЕДУМОВИ РОЗРОБКИ МАТЕМАТИЧНОЇ МОДЕЛІ РУХУ НАСІННЯ ГАРБУЗА У ВІБРАЦІЙНІЙ СУШАРЦІ.....	12
<i>Граняк В. Ф., Солоня О. В.</i> ПЕРСПЕКТИВИ ВИЯВЛЕННЯ ДЕФЕКТІВ ОБЕРТОВИХ ЕЛЕКТРИЧНИХ МАШИН НА ОСНОВІ АНАЛІЗУ ЇХ ВІБРОСИГНАЛІВ.....	20
<i>Омельянов О. М., Токарчук О. А.</i> ОБҐРУНТУВАННЯ АМПЛІТУДНО-ЧАСТОТНИХ ХАРАКТЕРИСТИК ТА КОНСТРУКТИВНИХ ПАРАМЕТРІВ СЕПАРАТОРА З ВІБРАЦІЙНИМ ПРИВОДОМ ЗБУДЖЕННЯ ПРОСТОРОВИХ КОЛИВАНЬ.....	30
<i>Мельник В. М., Косова В. П., Остапенко Ж. І., Швиденко В. В.</i> ДОСЛІДЖЕННЯ ВПЛИВУ УЛЬТРАЗВУКУ НА М'ЯСНУ СИРОВИНУ.....	38
<i>Ярошенко Л.В., Чубик Р.В.</i> ОБҐРУНТУВАННЯ ПАРАМЕТРІВ НЕЙРОКОНТРОЛЕРА ДЛЯ СИСТЕМИ КЕРУВАННЯ ВІБРОПРИВОДОМ АДАПТИВНИХ ВІБРАЦІЙНИХ ТЕХНОЛОГІЧНИХ МАШИН.....	44

2. МАШИНОБУДУВАННЯ ТА МАТЕРІАЛООБРОБКА

<i>Sevostianov I., Melnyk O.</i> ELABORATION AND RESEARCHES OF APPARATUS OF CONTROL FOR HYDROPONIC INSTALLATIONS.....	57
<i>Бовсуновський А. П., Носаль О. М.</i> МОДЕЛЮВАННЯ РОЗВИТКУ ТРІЩИНИ ВТОМИ ПРИ ПОПЕРЕЧНИХ КОЛИВАННЯХ ВАЛУ ТУРБІНИ.....	63
<i>Веселовська Н. Р.</i> РОЗРОБКА АЛГОРИТМІЧНОГО ЗАБЕЗПЕЧЕННЯ ДЛЯ ПРАКТИЧНОЇ РЕАЛІЗАЦІЇ ВИПРОБУВАЛЬНО-ДІАГНОСТИЧНОГО КОМПЛЕКСУ ВЕРСТАТІВ З ЧПК.....	71
<i>Матвійчук В. А., Михалевиц В. М., Колісник М. А.</i> ОЦІНКА ДЕФОРМОВНОСТІ МАТЕРІАЛУ ЗАГОТОВОК ПРИ ПРЯМОМУ І ЗВОРОТНОМУ ВИТИСКУВАННІ МЕТОДОМ ШТАМПУВАННЯ ОБКОЧУВАННЯМ.....	81
<i>Сивак Р. І., Островський А. Й., Залізняк Р. О.</i> ВИЗНАЧЕННЯ КІНЕМАТИЧНИХ ХАРАКТЕРИСТИК ПЛАСТИЧНОЇ ТЕЧІЇ МЕТАЛУ В УМОВАХ ОСЬОВОЇ СИМЕТРІЇ ПРОЦЕСУ ДЕФОРМУВАННЯ.....	92
<i>Яропуд В. М., Грицун А. В., Мазур І. М.</i> ПЕРСПЕКТИВНІ ТЕХНОЛОГІЇ І ТЕХНІЧНІ ЗАСОБИ ОБРОБКИ РІДКОГО ГНОЮ НА СВИНОФЕРМАХ.....	98
<i>Trukhanska O.</i> RESEARCH OF THE WORKING PROCESS OF THE CLEANING SYSTEM OF MACHINES FOR HARVESTING ROOT CROPS.....	106

3. ПЕРЕРОБНІ ТА ХАРЧОВІ ВИРОБНИЦТВА

<i>Присяжнюк Д. В.</i> ДОСЛІДЖЕННЯ ЕНЕРГЕТИЧНОЇ ЕФЕКТИВНОСТІ СУШІННЯ ЗЕРНОВОЇ СИРОВИНИ З ВИКОРИСТАННЯМ ВІБРООЗОНУЮЧОГО КОМПЛЕКСУ.....	117
<i>Полевода Ю. А., Соломон А. М., Бондар М. М.</i> МОДЕРНІЗАЦІЯ ОБЛАДНАННЯ ДЛЯ ВИРОБНИЦТВА СИРНОГО ПРОДУКТУ.....	124
<i>Шибецький В. Ю., Остапенко Ж. І., Фесенко В. В.</i> ДОСЛІДЖЕННЯ ГІДРОДИНАМІКИ І ТЕПЛООБМІНУ У ВІНОСНИХ ТЕПЛООБМІННИХ ЕЛЕМЕНТАХ ЕКСТРАКТОРІВ.....	132

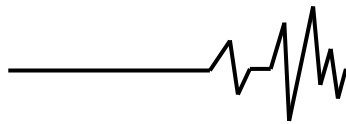
**Trukhanka O.**

Ph.D., Associate Prof.

**Vinnitsia National Agrarian
University****Труханська О. О.**

К.Т.Н., доцент

**Вінницький національний
аграрний університет****УДК 631.33.024****DOI: 10.37128/2306-8744-2022-1-13****RESEARCH OF THE WORKING
PROCESS OF THE CLEANING
SYSTEM OF MACHINES FOR
HARVESTING ROOT CROPS**

Conducted the theoretical and experimental studies of the combined cleaning system functioning process by analyzing the motion of fodder beet through the working surfaces of feeding conveyor and auger installed above it. We have got analytical and empirical process model of fodder beet oblique sub-hit on the augerturn that characterize the dependence of the total rate of sub-hit coefficient of technological interaction of roots and depth of root damage on the main parameters of combined cleaning system. We found out the rational limits of basic structural and kinematic parameters of combined cleaning system by provided minimum of fodder beet damage.

Particular importance for improving the design and technological level and individual working bodies of the combined cleaning system should be given to issues of general engineering problems of machine design: improvement of working bodies and other structural elements of the combined cleaning system based on a deeper analysis of physical and mechanical properties of roots. Characteristics of fodder beets, as an element of the system "machine-working body-root crop", must be considered as a set of different mechanical qualities and parameters that are decisive in the total mechanical action on the object, their allowable level and range of structural and kinematic parameters of workers bodies. When optimizing the parameters of transport and technological systems of the root of the harvesting machine, which have working bodies of screw mechanisms, at the stage of their design it is advisable to first build a mathematical model of the technological process of root cleaning system parameters.

Keywords: *root crops, cleaning system, feeding conveyor, total rate, the rate of technological interaction, speed of auger rotation, diameter of auger, damage of fodder beet.*

Introduction. The need to improve the working bodies and structural elements of root-harvesting machines based on a deeper analysis of the physical and mechanical properties of root crops is given special attention among a number of general engineering problems of machine design to improve the design and technological level and individual working bodies of root-harvesting machines [1].

Physical and mechanical properties of plants are used to develop technological processes and individual operations, as well as to determine the parameters and modes of operation of agricultural machinery. Production use of cleaning working bodies of fodder beet harvesting machines has shown that the total damage to root crops can be up to 40% depending on their

agrobiological characteristics. Improvement of working bodies and other structural elements of root-harvesting machines should be based on a deeper analysis of the physical and mechanical properties of fodder beets [2].

The improvement of structural and technological level and individual work of the root crop machine needs particular attention in general issues of machinery engineering design, improvement of working bodies and other structural elements of root crop machine based on deeper analysis taking into account the physical and mechanical properties of root crops [3].

Analysis of recent research and publications. Characteristics of fodder beet as an element of "machine - work body - root" should be considered as a set of different mechanical



properties and parameters that are decisive in total mechanical action on the object of treatment, its acceptable level and range of structural and kinematic parameters of working parts [4].

During parameter optimization of transport and technological systems of root-harvesting machines, which have working bodies of auger mechanisms at the stage of design it is expedient initially to construct a mathematical model of the process of the cleaning system to obtain patterns of its functioning according to fundamental structural and kinematic parameters [5].

The purpose of research is the further development of methodology and methods of optimization parameters of root pilecombined cleaners of root-harvesting machines.

Materials and methods. To develop specific processes and operations and to determine the parameters and modes of agricultural machines physical and mechanical properties of plants are taken in consideration. Industrial use of cleaning bodies of machines for harvesting fodder beet showed that total damage to root crops can be up to 40% depending on their agrobiological characteristics. Improving the working bodies and other structural elements root crop machinery should be based on a deep analysis taking into account the physical and mechanical properties of fodder beet. At this stage, it was presented a generalized picture of the behavior of fodder beet at different sub-hit speeds and, above all, those working bodies, which in real terms are used in the design schemes of root-harvesting machines [6].

To establish the patterns of change of the total sub-hit speed V_{ck} coefficient of technological interaction of root damage K_T and root crops depending on the parameters CCS, it was conducted the experimental research complex of root sub-hit process on the auger turn using a pendulum copra, Fig. 1.

It consists of a bracket 1, on which it is mounted a ball joint 2, 3 spherical bearing, which is fixed on pendulum axle 4. On the shorter upper end of the pendulum 5 it is set a body 6 with the spring-loaded pencil 7, on which there is hemisphere surface 8, mounted on props 9, which are rigidly connected to the bracket. At the longer bottom end of pendulum it is a fixed root 11, which rests on the screen 12. The inner surface of hemisphere it is applied a scale that shows on the angle from the vertical position turned and turned pendulum.

This pendulum copra A is set by the auger 12 so that the pattern of root 11 at rest (the vertical position of the pendulum) touches the auger rotation 13 at the point M, which is located in the

horizontal plane situated on the axis of auger rotation.

Sub-hit angle γ is adjustable between 0 ... 90°. Hemisphere surface radius is equal to the distance from the center of ball bearings, or the axis of rotation of the pendulum to the spring-loaded tip pencil.

At the time of passage of root crops the lowest point, when the pendulum copra declined from the vertical at a fixed angle γ , there is a hit (contact) of the root surface with the auger rotation that rotates forward with movement speed of root crops n .

As a result of the hit (contact) the root deviates from the auger with the overall rate of sub-hit V_{ck} , with pencil writing line on the inside surface of hemisphere. Its length and direction depend on the deflection γ of pendulum copra axis from vertical (the initial rate of root sub-hit V_e with auger, weight of root m_k , type of sub-hit surface (metallic surface) and auger options.

The resulting speed of root sub-hit \mathcal{G}_p with surface of the auger coil we determined the length by the line, which the pencil wrote after the sub-hit and it was consistent with the direction of the vector with regard

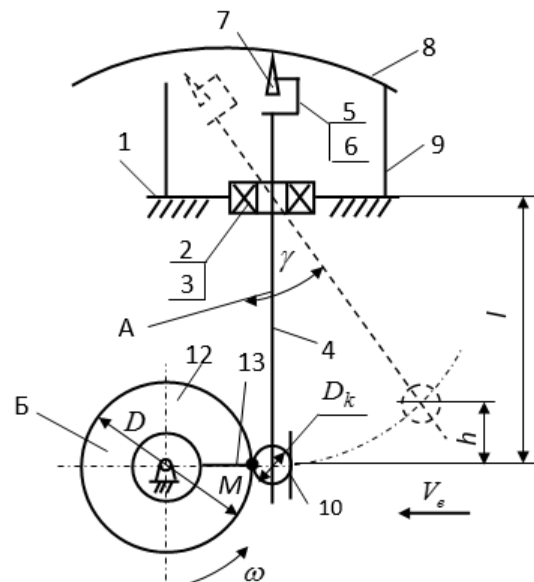

Fig. 1. Construction scheme of laboratory setup:
 1 - bracket; 2 - ball joints; 3 - spherical bearing;
 4 - the lower axle pendulum; 5 - upper pendulum axle; 6 - the body; 7 - loaded pencil; 8 - hemisphere surface; 9 - proper; 10 - screen; 11 - root; 12 - the auger; 13 - round

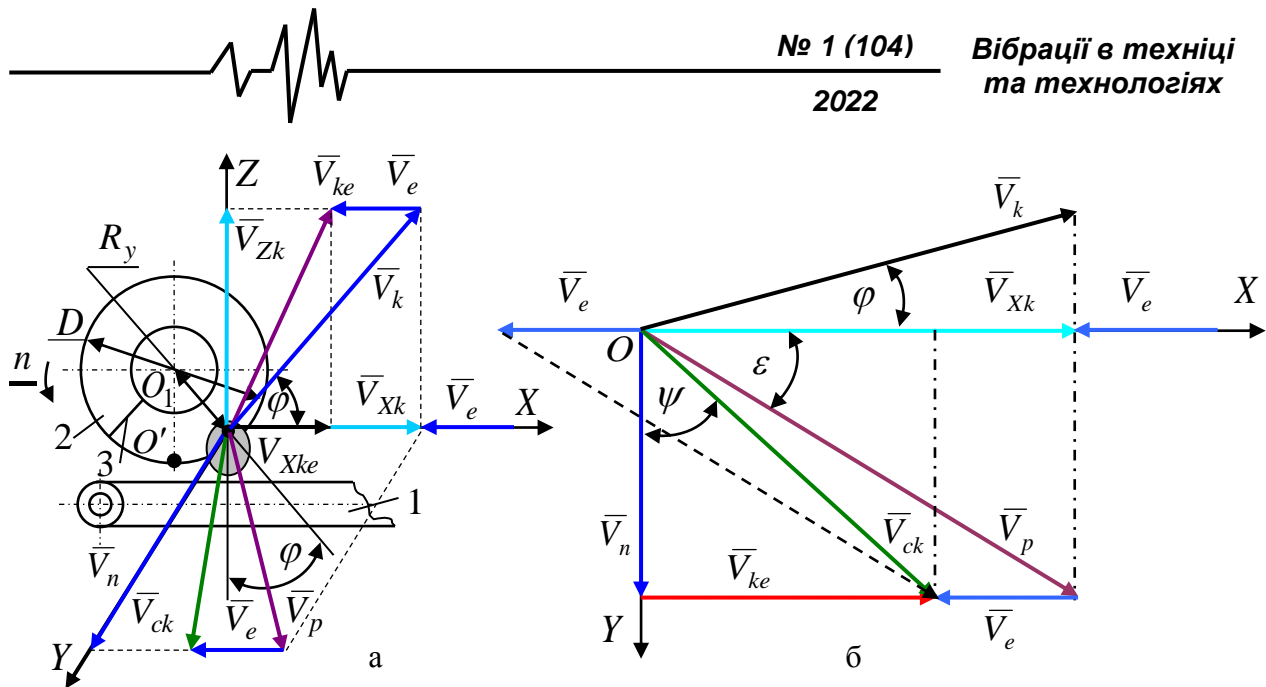

Fig. 2. Circuit design (a) and plan of velocity (b) oblique impact of root with work surfaces CCS: 1 - elevator; 2 - screw; 3 - turn screw

to certain sizes. The velocity scale was determined by dividing the calculated numerical value \mathcal{G}_c that had been determined by known methods of pendulum coprotation, on the measured length of the corresponding line. Then the length of the line (vector) \mathcal{G}_p multiplied the scale.

The study was conducted based on the realization three-factor experiment. Auger step was constant and was $T = 0.5$ m, lifting spiral angle $\beta = 27.5$ degrees. The diameter of the auger changed by mounting on the main auger diameter of 0.4 m additional turns of the respective heights.

The nature of the fodder beet damage was determined by the depth of the body damage h_n : deeply damaged - when the depth of the root damage was $h_n > 30$ mm; non-deply damaged - when $10 \leq h_n \leq 30$ (mm) [7].

Optimization parameter, the total change in sub-hit velocity coefficient V_{ck} of technological interaction of root K_T with auger spiral and damage to roots (the depth of body damage of fodder beet h_n), depending on three factors (frequency of auger rotation $n \rightarrow x_1$, auger diameter $D \rightarrow x_2$, mass of roots $m_k \rightarrow x_3$ by sub-hit initial speed $V_e = 1.6$ m / s) determined by experiment, were found in the form of a mathematical model of the polynomial second degree and logarithmic functions.

Results. The main criteria that characterize the technological process of separation dug pile is the degree of separation of

impurities from the roots and exponent of roots damaged in the process of interaction with the CCS work surfaces. To assess the degree of damage to the roots, the maximum values that arise during their interaction with the auger 2 rotation 3 of CCS (Fig. 1), we introduce the rate of technological root interaction, which expresses the ratio $K_T = [V_{max}] / V_{ck} \geq 1$.

The maximum permissible hit speed $[V_{max}]$ of fodder beet with working surfaces is limited by allowable data (Baranovsky V.M., Voytyuk D.G., Vyhovsky A.J., 2001), which when exceeded get root damage not exceeding the limits of deeply and non-deeply damaged roots according to the requirements (State Standart 2258-93, 1993).

To determine the total speed rate V_{ck} there is the design scheme (Fig. 2a). In this case, the interaction of root of the auger 2 rotation 3 we look in terms of striking force action at the material body, and the root interacts with the surface of the auger coil screw at point O, which rotates with frequency n . The initial impact velocity V_e is denoted by a root crop which value corresponds to the speed of the elevator rod 1. The point O of impact is at a distance R_y from the axis of rotation O_1 of the auger. After impact, root reflected from the surface of the final round of the auger overall rate V_{ck} and moving in its direction at an angle ψ .

The general case of hit interaction of two bodies is characterized by a change of angular and translational velocities of the coordinate axes spatial system $OXYZ$. In an oblique hit there are various types of frictional interaction and compression deformation of roots body, respectively, tangential and normal hit pulse, the



result of compression deformation is the appearance of cracks in the body of root or cracking. Reducing the normal pulse hit possible by reducing the total V_{ck} speed, the implementation of which is achieved by reducing the normal component V_{ck} or as a result - by reducing the angle sub-hit surface β .

In this regard, let's consider the terms of speed oblique roots hit and auger rotation in the horizontal plane OXY (Fig. 2b), assuming that speed before and after sub-hit change the roots only.

From the analysis of speeds schema here are:

$$\left. \begin{aligned} \bar{V}_{ke} &= \sqrt{\bar{V}_k^2 - \bar{V}_e^2}; \\ \bar{V}_p &= \sqrt{\bar{V}_{Xk}^2 + \bar{V}_n^2} = \sqrt{\bar{V}_k^2 \cos^2 \varphi + \bar{V}_n^2}; \\ \bar{V}_{ck} &= \sqrt{\bar{V}_{ke}^2 + \bar{V}_n^2} = \sqrt{(\bar{V}_k - \bar{V}_e)^2 + \bar{V}_n^2} \end{aligned} \right\};$$

$$\left. \begin{aligned} \bar{V}_k &= \frac{d\bar{R}_y}{dt} = \bar{\omega} \times \bar{R}_y; \quad \omega = \frac{d\varphi}{dt} = \dot{\varphi} = 2\pi n; \\ V_n &= V_{nT} K_{Vn} = T n K_{Vn} = \frac{TK_{Vn}\omega}{2\pi}; \quad T = \pi D_y \text{tg} \beta; \\ \bar{V}_e &= \frac{d\bar{r}_e}{dt} = \bar{\omega}_e \times \bar{r}_e; \quad \omega_e = \frac{d\varphi_e}{dt} = \dot{\varphi}_e = 2\pi n_e \end{aligned} \right\}. \quad (1)$$

From equations (1) we have the differential equation of scalar total speed V_{ck}

$$V_{ck} = \frac{dl_k}{dt} = \sqrt{\left[\left(\frac{D \cos \varphi}{2} \frac{d\varphi}{dt} \right) - \left(\frac{D_e}{2} \frac{d\varphi_e}{dt} \right) \right]^2 + \left(\frac{DK_{Vn} \text{tg} \beta}{2} \frac{d\varphi}{dt} \right)^2}, \quad (2)$$

or simplification dependence on (2) and conditions $K_T = [V_{max}] / V_{ck} \geq 1$

$$V_{ck} = \frac{1}{2} \sqrt{D^2 (\cos^2 \varphi + K_{Vn}^2 \text{tg}^2 \beta) \left(\frac{d\varphi}{dt} \right)^2 + D_e \frac{d\varphi_e}{dt} \left(D_e \frac{d\varphi_e}{dt} - 2D \cos \varphi \frac{d\varphi}{dt} \right)}; \quad (3)$$

$$K_T = \frac{2[V_{max}]}{\sqrt{D^2 (\cos^2 \varphi + K_{Vn}^2 \text{tg}^2 \beta) \left(\frac{d\varphi}{dt} \right)^2 + D_e \frac{d\varphi_e}{dt} \left(D_e \frac{d\varphi_e}{dt} - 2D \cos \varphi \frac{d\varphi}{dt} \right)}} \geq 1. \quad (4)$$

The resulting differential equation (4) describes the adaptability of CCS or technological dependence of the coefficient of interaction of root

auger spiral on the basic parameters of the cleaning system.

Given (1) dependence (4) will look like:

$$K_T = \frac{[V_{max}]}{\pi \sqrt{D^2 n^2 (\cos^2 \varphi + K_{Vn}^2 \text{tg}^2 \beta) + D_e n_e (D_e n_e - D n \cos \varphi)}} \geq 1. \quad (5)$$

Analysis of Fig. 1, a shows that after hitting the root reflects from the surface of the auger coil with the ultimate total speed V_{ck} and moves in the direction of the vector \bar{V}_{ck} which projection on a horizontal plane OXY of the velocity vector turns axial movement of the auger \bar{V}_n , forms an angle ψ . Upon reaching speed $V_{ck} = dl_k / dt = 0$, by root feeding conveyor, root moving back toward the auger and re-experiencing the hit interaction with the working surface of the auger coil.

In this case, it can be concluded that minimal damage to roots and maximum adaptability of CCS will also be provided when the angle is of $\psi \leq 0$ or when roots move along the axis of auger rotation.

According to Fig. 1, there are

$$V_{ke}^2 = V_n^2 + V_{ck}^2 + 2V_n V_{ck} \cos \psi, \quad (6)$$

or

$$\left(\frac{dl_k}{dt} \right)^2 + 2 \left(\frac{DK_{Vn} \text{tg} \beta}{2} \frac{d\varphi}{dt} \right) \left(\frac{dl_k}{dt} \right) \cos \psi + \left(\frac{DK_{Vn} \text{tg} \beta}{2} \frac{d\varphi}{dt} \right)^2 - \left(\frac{D \cos \varphi}{2} \frac{d\varphi}{dt} - \frac{D_e}{2} \frac{d\varphi_e}{dt} \right)^2 = 0. \quad (7)$$

Marking in (7) through the appropriate



parts: $\frac{dl_k}{dt} = x$; $DK_{vn} \operatorname{tg} \beta \cos \psi \frac{d\varphi}{dt} = p$;

solution is according to x looks like:

$$\left(\frac{DK_{vn} \operatorname{tg} \beta \frac{d\varphi}{dt}}{2} \right)^2 - \left(\frac{D \cos \varphi \frac{d\varphi}{dt}}{2} - \frac{D_e \frac{d\varphi_e}{dt}}{2} \right)^2 = q$$

obtain harmonized quadratic equation, the

$$\frac{dl_k}{dt} = -\frac{DK_{vn} \operatorname{tg} \beta \frac{d\varphi}{dt}}{2} \pm \frac{1}{2} \sqrt{\left(DK_{vn} \operatorname{tg} \beta \frac{d\varphi}{dt} \right)^2 (\cos^2 \psi - 1) - \left(D \cos \varphi \frac{d\varphi}{dt} - D_e \frac{d\varphi_e}{dt} \right)^2}, \quad (8)$$

with two valid datas dl_k / dt are provided:

Thus, the theoretical dependence that characterizes the correlation coefficient K_T and the basic parameters of the cleaning system is as follows:

$$-\left(D \cos \varphi \frac{d\varphi}{dt} - D_e \frac{d\varphi_e}{dt} \right)^2 \leq 0. \quad (9)$$

$$K_T = \frac{2[V_{max}]}{-DK_{vn} \operatorname{tg} \beta \frac{d\varphi}{dt} \pm \sqrt{\left(DK_{vn} \operatorname{tg} \beta \frac{d\varphi}{dt} \right)^2 (\cos^2 \psi - 1) - \left(D \cos \varphi \frac{d\varphi}{dt} - D_e \frac{d\varphi_e}{dt} \right)^2}} \geq 1. \quad (10)$$

Given (1), for the practical use of dependency (7), (10) we can write:

$$\left. \begin{aligned} V_{ck} &= -\pi D n K_{vn} \operatorname{tg} \beta \pm \pi \sqrt{\left(D n K_{vn} \operatorname{tg} \beta \right)^2 (\cos^2 \psi - 1) - \left(D n \cos \varphi - D_e n_e \right)^2}; \\ K_T &= \frac{[V_{max}]}{-D n K_{vn} \operatorname{tg} \beta \pm \pi \sqrt{\left(D n K_{vn} \operatorname{tg} \beta \right)^2 (\cos^2 \psi - 1) - \left(D n \cos \varphi - D_e n_e \right)^2}} \geq 1 \end{aligned} \right\} \quad (11)$$

The dependence of the angle ψ between the vector projection \bar{V}_{ck} on a horizontal plane of OXY of axial movement velocity vector auger turns \bar{V}_n on the basic parameters of CCS can be represented as [8]:

$$\psi = \arcsin \left(\frac{\sqrt{1 + \frac{D^2 \operatorname{tg}^2 \beta \left(\frac{d\varphi}{dt} \right)^2}{\pi \left(D \cos \varphi \frac{d\varphi}{dt} - D_e \frac{d\varphi_e}{dt} \right)^2}}}{\pi \left(D \cos \varphi \frac{d\varphi}{dt} - D_e \frac{d\varphi_e}{dt} \right)^2} \right)^{-1}. \quad (12)$$

passage fodder beet (at their total length), and maximum speed of movement along the centerline of rotation of the auger, with which $\beta = 45^\circ - 0,5\varphi_k$, when $\varphi_k = 35^\circ$, then $\beta = 27,5$ degrees [8].

Substituting the data (12) in relation (8) we obtained mathematical model that describes the technological process of kinematic interaction of fodder beet with auger rotation and functionally connects the magnitude and direction of the total sub-hit velocity of roots V_{ck} with options CCS:

Step of spiral T and angle lifting spiral β on the outside diameter in the design of auger working bodies select by the condition of free

$$\begin{aligned} &2 \frac{dl_k}{dt} + DK_{vn} \operatorname{tg} \left(45 - \frac{\varphi_k}{2} \right) \frac{d\varphi}{dt} = \\ &= \sqrt{\left(DK_{vn} \operatorname{tg} \left(45 - \frac{\varphi_k}{2} \right) \frac{d\varphi}{dt} \right)^2 \left\{ \cos^2 \left[\arcsin \left(\frac{1}{2} \sqrt{1 + \frac{D^2 \operatorname{tg}^2 \left(45 - \frac{\varphi_k}{2} \right) \left(\frac{d\varphi}{dt} \right)^2}{\pi \left(D \cos \varphi \frac{d\varphi}{dt} - D_e \frac{d\varphi_e}{dt} \right)^2}} \right) \right] - 1 \right\} - \left(D \cos \varphi \frac{d\varphi}{dt} - D_e \frac{d\varphi_e}{dt} \right)^2}, \quad (13) \end{aligned}$$

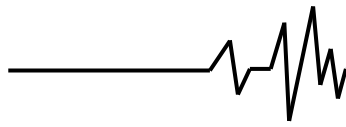

or coefficient K_T

$$K_T = \frac{2[V_{max}]}{-DK_{vn}tg\left(45 - \frac{\varphi_k}{2}\right)\frac{d\varphi}{dt} \pm \sqrt{\left(DK_{vn}tg\left(45 - \frac{\varphi_k}{2}\right)\frac{d\varphi}{dt}\right)^2 \cos^2 \left[\arcsin \left[\frac{1}{2} \sqrt{1 + \frac{D^2 tg^2 \left(45 - \frac{\varphi_k}{2}\right) \left(\frac{d\varphi}{dt}\right)^2}{\pi \left(D \cos \varphi \frac{d\varphi}{dt} - D_e \frac{d\varphi_e}{dt}\right)^2}} \right] \right] - 1} \geq 1 \quad (14)$$

Considering previously adopted hypothesis that minimizing damage fodder beet and maximum adaptability of CCS will be provided when the angle of $\psi = 0$ or expression $\cos^2 \psi - 1 = 0$ (adequacy of which follows from the analysis of dependence (8), mathematical models (13) (14) are given as follows:

$$2 \frac{dl_k}{dt} + DK_{vn}tg\left(45 - \frac{\varphi_k}{2}\right)\frac{d\varphi}{dt} = D_e \frac{d\varphi_e}{dt} - D \cos \varphi \frac{d\varphi}{dt};$$

$$K_T = \frac{2[V_{max}]}{-DK_{vn}tg\left(45 - \frac{\varphi_k}{2}\right)\frac{d\varphi}{dt} \pm D_e \frac{d\varphi_e}{dt} - D \cos \varphi \frac{d\varphi}{dt}} \geq 1 \quad (15)$$

The obtained dependences (15) are mathematical models which functionally regulate kinematic technological process of interaction of fodder beet with auger revolution by minimum of their damage.

In terms of implementation of this theoretical hypothesis, taking into account (12) it can be written that the condition $\cos^2 \psi - 1 = 0$ will be realized when, $\cos \psi = \sqrt{1 - \sin^2 \psi} = 1, \cos^2 \psi = 1, \sin \psi = 0$ that is

$$\sin \psi = \sqrt{1 + \frac{D^2 tg^2 \beta \left(\frac{d\varphi}{dt}\right)^2}{\pi \left(D \cos \varphi \frac{d\varphi}{dt} - D_e \frac{d\varphi_e}{dt}\right)^2}} = 0$$

$$= \frac{1}{\sqrt{1 + \frac{D^2 n^2 tg^2 \left(45 - \frac{\varphi_k}{2}\right)}{\pi \left(D n \cos \varphi - D_e n_e\right)^2}}} = 0$$

Fig. 2 shows the dependence of the angle $\sin \psi$ as functional: a, b - $\sin \psi = f(d, n)$; c - $\sin \psi = f(d)$ by $\varphi_k = 35,0$ degrees.; $\varphi = 45,0$ degrees.

The analysis (Fig. 2) we found that the condition to ensure minimal damage of fodder beet

($\psi = 0$) functionality implemented in the following ratio combinations of diameter and rotational speed of the auger n : $D=0.4$ m, $n = 1.65$ rev / s (99 rev / min.); $D=0.5$ m, $n = 1.5$ r / s (90 rev / min.); $D=0.6$ m, $n = 1.2$ r / s (72 rev / min.); $D=0.7$ m, $n = 1.0$ r / s (60 rev / min.); $D=0.8$ m, $n = 0.85$ rev / s (50 rev / min.).

But these assertions are quite likely (adequacy of these combinations of parameters auger will actually meet the practical implementation of the process of CCS) in the condition to provide the necessary computational performance of auger and its permissible angular velocity [6] which technology delivers this performance cleaning system and condition to minimize root damage.

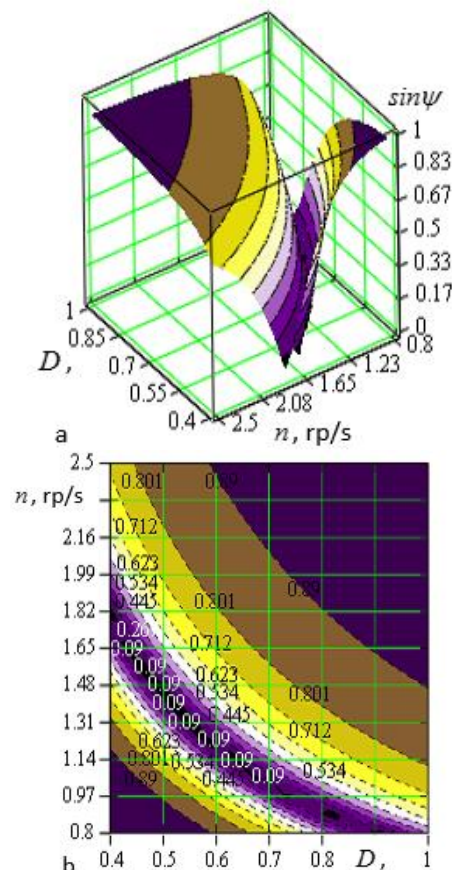

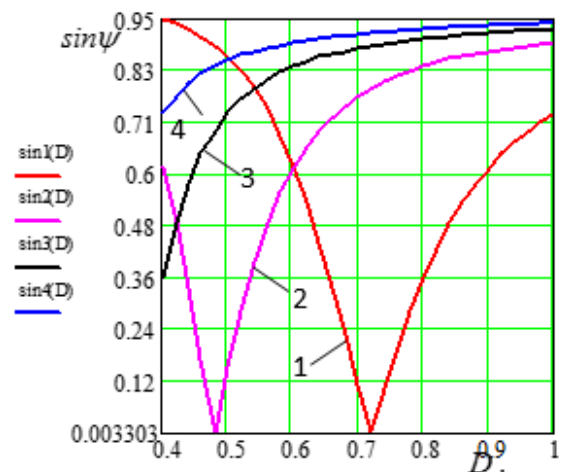
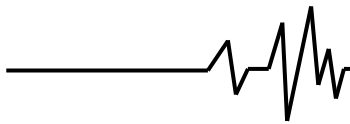

Fig. 2. Dependence of angle change ψ :
a, b - $\sin \psi = f(d, n)$; c - $\sin \psi = f(d)$; 1 -
 $n = 50$ rev/min; 2 - $n = 90$ rev/min;
3 - $n = 120$ rev/min; 4 - $n = 150$ rev/min.

$$\left. \begin{aligned} V_{ck}^{1.0e} &= 0,48 + 0,009x_1 + 2,43x_2 + 0,012x_1x_2 + 1,33 \cdot 10^{-5}x_1^2 - 0,67x_2^2; \\ V_{ck}^{1.0e} &= -10,3 - 4,21 \cdot 10^{-4}n + 31,03D + 1,2 \cdot 10^{-3}nD + 5,32 \cdot 10^{-9}n^2 - 19,0D^2; \\ V_{ck}^{1.5e} &= 0,44 + 0,009x_1 + 2,33x_2 + 0,012x_1x_2 + 1,33 \cdot 10^{-5}x_1^2 - 0,67x_2^2; \\ V_{ck}^{1.5e} &= -10,09 - 4,21 \cdot 10^{-4}n + 30,53D + 1,2 \cdot 10^{-3}nD + 5,32 \cdot 10^{-9}n^2 - 19,0D^2; \\ V_{ck}^{2.0e} &= 0,46 + 0,009x_1 + 2,38x_2 + 0,012x_1x_2 + 1,33 \cdot 10^{-5}x_1^2 - 0,67x_2^2; \\ V_{ck}^{2.0e} &= -10,2 - 4,21 \cdot 10^{-4}n + 30,78D + 1,2 \cdot 10^{-3}nD + 5,22 \cdot 10^{-9}n^2 + 19,0D^2 \end{aligned} \right\}; \quad (17)$$

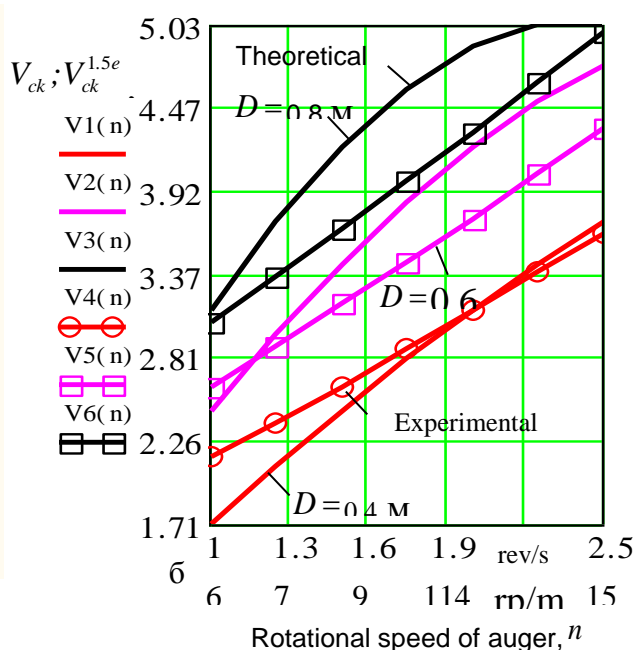
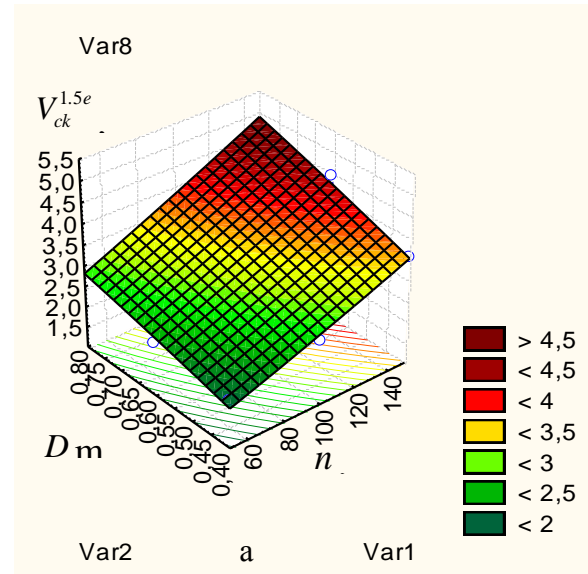
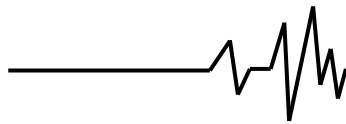

Fig. 3. Resposesurface (a) dependencies $V_{ck}^{1.5e} = f(n, D)$; b – theoretical dependencies $V_{ck} = f(n)$: experimental dependencies $V_{ck}^{1.5e} = f(n)$



$$\left. \begin{aligned} K_T^{1.0e} &= 2,37 - 0,01x_1 - 1,38x_2 + 0,003x_1x_2 + 1,6 \cdot 10^{-5}x_1^2 + 0,25x_2^2; \\ K_T^{1.0e} &= 7,42 - 3,51 \cdot 10^{-4}n - 13,18D + 3,0 \cdot 10^{-4}nD + 6,4 \cdot 10^{-9}n^2 + 6,25D^2; \\ K_T^{1.5e} &= 2,45 + 0,01x_1 - 1,35x_2 + 0,003x_1x_2 + 1,67 \cdot 10^{-5}x_1^2 + 0,17x_2^2; \\ K_T^{1.5e} &= 6,92 - 3,51 \cdot 10^{-4}n - 11,03D + 3,0 \cdot 10^{-4}nD + 6,7 \cdot 10^{-9}n^2 + 4,25D^2; \\ K_T^{2.0e} &= 2,4 - 0,01x_1 - 1,32x_2 + 0,003x_1x_2 + 1,67 \cdot 10^{-5}x_1^2 + 0,17x_2^2; \\ V_{ck}^{2.0e} &= 6,8 - 3,51 \cdot 10^{-4}n - 10,88D + 3,0 \cdot 10^{-4}nD + 6,7 \cdot 10^{-9}n^2 + 4,25D^2 \end{aligned} \right\} \quad (18)$$

Analysis of the regression equations (17), (18) and constructed according to these surfaces response of dependencies $V_{ck}^{ie} = f(n, D)$, $K_T^{ie} = f(n, D)$ that are shown in Fig. 3a, and; 4a, shows that the change V_{ck}^{ie} i K_T^{ie} and depending on the mass of roots that sub-hitauger within change $1,0 \leq m_k \leq 2,0$ (kg) hasinsustainable character - corresponding growth rate of total sub-hit is $\Delta V_{ck} \approx 0,2...0,4$ m / s and reduction of $\Delta K_K^e \approx 0,06...0,13$. Therefore, for practical calculations V_{ck}^e i K_T^e are recommended appropriate regression depending average values of the mass of roots that $V_{ck}^{1.5e}$ i $K_T^{1.5e}$ and dependencies (17) and (18).

Analysis of the image dependencies, built on empirical regression equation (18) shows the condition $K_T^{1.5e} \geq 1,0$ in which the roots get damaged, are not beyond the agronomic requirements RM [6] is provided with the following limits of correlation of structural and kinematic parameters CCS: $D=0.6$ m, $n \leq 80.0$ / min .; $D=0.5$ m, $n \leq 100.0$ rev / min .; $D=0.4$ m, $n \leq 140.0$ rev / min. For $D=0.8$ m diameter changes within $50 \leq n \leq 150$ rev / min.

$K_T^{1.5e} \geq 1,0$ the condition is not satisfied.

The discrepancy between the experimental $V_{ck}^{1.5e}$, $K_T^{1.5e}$ and theoretical V_{ck} , K_T values of total sub-hit speed factor and technological interaction of root with auger revolution is within 1,3 ... 1,5%, which is a theoretical mathematical model (13) (14) adequate to actually existing process and significantly describe the interaction of roots with auger revolution considering formalizing the research object [8].

After processing experimental data and statistical significance and obtaining coefficients and verifying the adequacy of distribution of random variables mathematical model of real process according to criteria of Fisher and Student we received empirical regression equation, which describes the dependence of damage to root crops of fodder beet these limits change factors: the frequency of rotation of the auger $50, 0 \leq n \leq 150.0$ rev / min .; screw diameter of $0.4 \leq D \leq 0.8$ m; root mass of $1.0 \text{ kg} \leq m_k \leq 2.0 \text{ kg}$:

- in coded factors:

$$h_n = -67,15 + 20,32 \ln x_1 + 21,22 \ln x_2 + 20,05 \ln x_3; \quad (19)$$

- the natural factors:

$$h_n = -67,15 + 20,32 \ln(n - 100) + 21,22 \ln(5D - 2,5) + 20,05 \ln(2m_k - 3). \quad (20)$$

According to the obtained regression equation (19) we constructed nomogram (Fig. 2) predicting the likely damage to the body of fodder beet corresponding to size-mass characteristics of the variety "Kyiv" depending on installed options combined cleaning system.

We use the nomogram as follows. For example, the selected parameters of the auger, speed of $n = 100$ rev/min and $D = 0.6$ m diameter, depth of the damage probable forecast fodder beet body weight of $m_k = 1.0$ kg will be about 15 mm, $m_k = 1.5$ kg - about 23 mm, $m_k = 2.0$ kg - about 29 mm, which corresponds to

non-deep damaged roots.

The general character changes depending on the depth of the body damage of fodder beet $m_k = 1,0-1,5-2,0$ customized weight (kg) in the range of $10 \leq h_n \leq 30$ mm (non-deep damaged roots) implemented on the basis of construction, this limited range of response surface (Fig. 3) and the change in the full range of body damage fodder beet displayed on the built bulk diagram in (Fig. 4).

Limit of deeply damaged roots ($h_n > 30$ mm) occurs at these auger parameter values (Fig. 4): root weighing $m_k = 1.0$ kg - with values $n \geq 150$



rev / min, $D \geq 0.8$ m; root mass $m_k = 1.5$ kg - with values $n \geq 100$ rev / min, $D \geq 0.8$ m; $n \geq 120$ rev / min, $D \geq 0.7$ m; $n \geq 150$ rev / min, $D \geq 0.6$ m; root $m_k = 2.0$ kg - with values $n \geq 80$ rev / min, $D \geq 0.8$ m; $n \geq 90$ rev / min, $D \geq 0.7$ m; $n \geq 110$ rev / min, $D \geq 0.6$ m; $n \geq 130$ rev / min, $D \geq 0.5$ m.

At lower values, given above, parameters of auger, proper combinations of rotational speed n and the diameter D of the auger, the depth h_n of the root damage will conform to the limits of non-deeply damaged roots, or condition $10 \leq h_n \leq 30$ mm. The results of the given above analysis of the possible damage to the body of fodder beet in their interaction with spiral auger cleaning system analysis also confirm the above graphic $h_n = f(D, n)$, $h_n = f(D, m_k)$, $h_n = f(n, m_k)$ dependences (Fig. 3) and $h_n = f(n)$ (Fig. 5).

In fact, if the soil is elastic between the turns of the auger and roots at the time of sub-hit imposed above limitation parameters of cleaner auger can be adjusted in the direction of their increase according to a second supply of soil contaminants to the cleaner, and the thickness of the soil will "adjust" the depth of the body damage of fodder beet, so this process will be unstable and random.

For analytical prediction of the possible damage to the root of fodder beet we received specified regression equation describing the change in the depth of the root damage h_n of fodder beet customized weight depending on the rpm n and the diameter D of the auger as functional $h_n^i = f(n, D)$, empirical form of which, after appropriate validation criteria of Fisher and Student, is described by polynomial second degree:

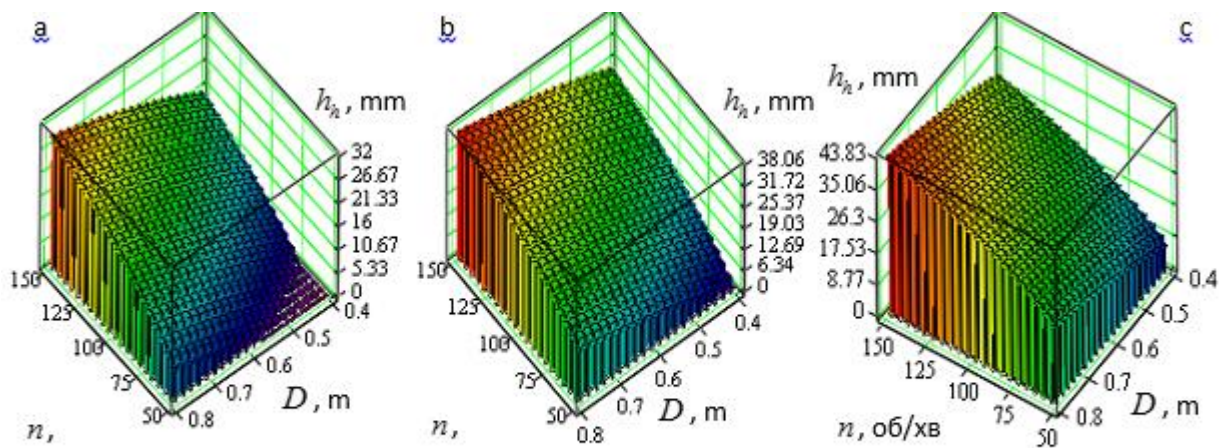

Fig. 4. The volume chart of changes h_n , as a function:

a - $h_n = f(D, n)$; b - $h_n = f(D, m_k)$; c - $h_n = f(n, m_k)$

$$\left. \begin{aligned} h_n^{1.0} &= 23,83 - 0,41x_1 - 55,83x_2 + 0,63x_1x_2 + 0,001x_1^2 + 25,0x_2^2; \\ h_n^{1.5} &= 15,94 - 0,01x_1 - 83,33x_2 + 0,28x_1x_2 + 0,0003x_1^2 + 70,83x_2^2; \\ h_n^{2.0} &= 7,61 + 0,18x_1 - 63,33x_2 + 0,23x_1x_2 + 0,0005x_1^2 + 78,57x_2^2 \end{aligned} \right\}. \quad (21)$$

Natural values regression equation (21) is:

$$\left. \begin{aligned} h_n^{1.0} &= 323,63 - 3,98 \cdot 10^{-2}n - 940,45D + 6,3 \cdot 10^{-2}nD + 0,004 \cdot 10^{-4}n^2 + 625,0D^2; \\ h_n^{1.5} &= 668,38 - 1,42 \cdot 10^{-2}n - 2190,2D + 2,8 \cdot 10^{-2}nD + 0,001 \cdot 10^{-4}n^2 + 1770,75D^2; \\ h_n^{2.0} &= 658,1 - 1,11 \cdot 10^{-2}n - 2283,2D + 2,3 \cdot 10^{-2}nD + 0,002 \cdot 10^{-4}n^2 + 1964,25D^2 \end{aligned} \right\}. \quad (22)$$

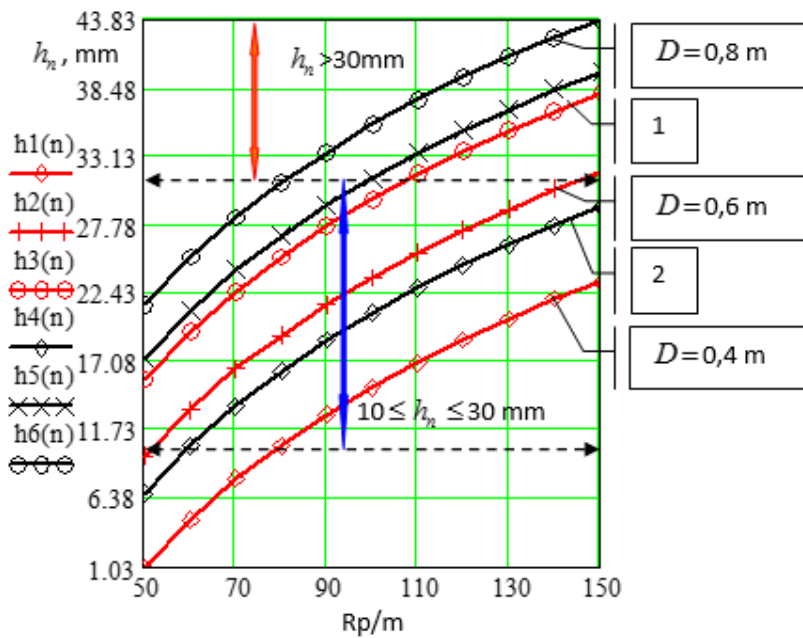
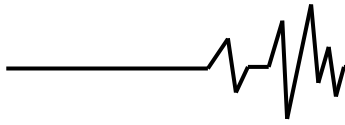

Fig. 5. Dependence of Root damage depth h_n on the auger speed:
1 – root weigh $m_k = 1,5\text{kg}$; 2 – root weigh $m_k = 2,0\text{ kg}$.

Within the changing factors: the frequency of rotation of the auger $50.0 \leq n \leq 150.0$ rev / min and auger diameter $0.4 \leq D \leq 0,8$ m, analyzing trends in the nature and extent of root damage of concretized mass of fodder beet, which is regulated constructed response surfaces (Fig. 6) root damage depth of mass concretized of fodder beet is identical to the process changing, which is described (19), (20).

Thus, on the basis of the analysis we can say that structural and kinematic parameters of auger that satisfy the condition and nature of root

damage $10 \leq h_n \leq 30$ mm, the average yield of fodder beet ... 500.0 550.0 kg / ha, the total length of $15.0 \leq L_{kc} \leq 20.0$ cm (corresponding to a mass of roots $1,5 \leq m_k \leq 2,0$ kg) will be within $D \leq 0.6$ m and $90 \leq n \leq 110$ (rev / min). Conditions of eliminate damage to $h_n \leq 10$ mm, is provided at the following values of the parameters of auger: $0.4 \leq D \leq 0.6$ (m) and $n \leq 75$ / min.

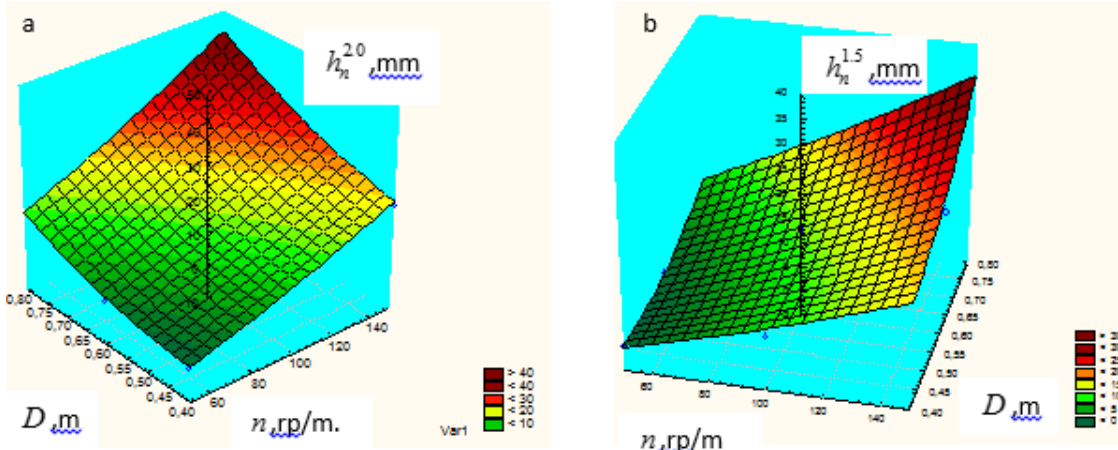

Fig. 6. The surface of response of depth damage of fodder beet h_n^i :
a – $h_n^{2.0} = f(n, D)$; b – $h_n^{1.5} = f(n, D)$

Conclusions. Built determined theoretical mathematical models of the interaction of root with the

auger rotation of cleaning system may, along with empirical derived regression equation (17), (18) be



used for further study of structural and kinematic parameters of technological systems of fodder beet pile cleaners of root crop harvesting machine.

It is established that structural and kinematic parameters of auger that satisfy the condition $10 \leq h_n \leq 30$ mm (non-deep damage) for the length of fodder beet $15.0 \leq L_{kc} \leq 20.0$ cm (corresponding weight $1.5 \leq m_k \leq 2.0$ kg) will be within $D \leq 0.6$ and $90 \leq n \leq 110$ (rev / min). Conditions ensuring no damage fodder beet ($h_n \leq 10$ mm) are performed by $0.4 \leq D \leq 0.6$ (m) and $n \leq 75$ / min.

References

1. Pogorelyj, L.V., & Tatyanko, M.V. (2004). Sveklouborochnye mashyny: istoriya, konstrukciya, teoriya, prognoz [Beet harvesting machines: history, construction, theory, forecast]. Kiev: Feniks [in Ukrainian].
2. Pohorilyi, M.L. (2000). Tekhnolohichni i tekhnichni aspekty vdoskonalennia buriakozbyralnoi tekhniki [Technological and technical aspects of improvement of beet-harvesting equipment]. Tekhnika APK – Machinery of agroindustrial complex, 1, 14-18 [in Ukrainian].
3. Pat. 28465 Ukraina, (2007) Ochysna systema vorokhu koreneplodiv [Cleansing system of rake root crops] / Baranovskyi, V.M. et al. / [in Ukrainian].
4. Baranovskyi, V.M., & Pankiv, M.R., & Dubchak, N.A. (2007). Ochysna systema vorokhu koreneplodiv [Cleansing system of rake root crops]. Visnyk KhNTUSH «Mekhanizatsiia s.-h.Vyrobnytstva» - Mechanization of agricultural production, 1, 33-36 [in Ukrainian].
5. Mashyny buriakozbyralni [Machine for harvesting beets]. (1993). DSTU 2258-93. Kyiv: Derzhstandart Ukraine [in Ukrainian].
6. Trukhanska, O.O. (2018). Tekhnologichna vzaemodiya koreneplodiv z gvintovoyu poverkneyu ochysnoi systemy [Technological interaction of the roots with the screw surface of the cleaning system]. Vibrations in engineering and technology, 4 (91), 63-68 [in English].
7. Baranovskyi, V.M. (2006). Osnovni etapy ta suchasni tendentsii rozvytku korenezbyralnykh mashyn [The main stages and modern trends of the development of the root harvesting machines]. Visnyk

TDTU – Bulletin of the Ternopil State Technical University, 2, 67-75 [in Ukrainian].

8. Baranovskyi, V.M., & Trukhanska, O.O. & Pankiv, M.R. (2020). Doslidzhennya vplyvu kontaktnoyi vzaemodiyi koreneplodiv z poverkneyu shneka [Research of a contact impact of a root crop with a screw auger]. Research in Agricultural Engineering, 66, (1): 33–42 [in English].

ДОСЛІДЖЕННЯ РОБОЧОГО ПРОЦЕСУ ОЧИСНОЇ СИСТЕМИ КОРЕНЕЗБИРАЛЬНОЇ МАШИНИ

Особливе значення для підвищення конструкторсько-технологічного рівня та окремих робочих органів комбінованої очисної системи слід надавати питанням загальнотехнічних проблем проектування машин: удосконаленню робочих органів та інших конструктивних елементів комбінованої системи очищення на основі більш глибокого аналізу фізико-механічні властивості коренів. При оптимізації параметрів очисних систем коренезбиральних машин, які мають шнекові робочі органи, на етапі їх проектування доцільно спочатку побудувати математичну модель технологічного процесу, що описує параметри коренеочисної системи.

Наведено теоретичні та експериментальні дослідження процесу функціонування очисної системи шляхом аналізу руху кормових буряків через робочі поверхні подаючого конвеєра та встановленого над ним шнека. Одержано аналітичну та емпіричну модель процесу косоного співудару кормових буряків з витком шнека, що характеризує залежність зміни сумарної швидкості співудару, коефіцієнта технологічної взаємодії коренеплодів та глибини пошкодження тіла коренеплодів від основних параметрів комбінованої очисної системи. Визначено раціональні межі основних конструктивно-кінематичних параметрів комбінованої очисної системи за умови мінімального пошкодження кормових буряків.

Ключові слова: коренеплоди, система очищення, подаючий транспортер, сумарна швидкість, швидкість технологічної взаємодії, швидкість обертання шнека, діаметр шнека, пошкодження кормових буряків.

Відомості про авторів

Труханська Олена Олександрівна – кандидат технічних наук, доцент, доцент кафедри агроінженерії та технічного сервісу Вінницького національного аграрного університету (вул. Сонячна, 3, м Вінниця, 21008, Україна, e-mail: seaswallow@ukr.net).

Olena Trukhanska – Candidate of Technical Sciences, Associate Professor, Associate Professor of the Department of Agroengineering and Technical Service of Vinnytsia National Agrarian University (Solnechnaya St., 3, Vinnytsia, 21008, Ukraine, e-mail: seaswallow@ukr.net).